

REVISIONS				
ZONE	REV.	DESCRIPTIONS	DATE	APP.

TOP MOUNTING

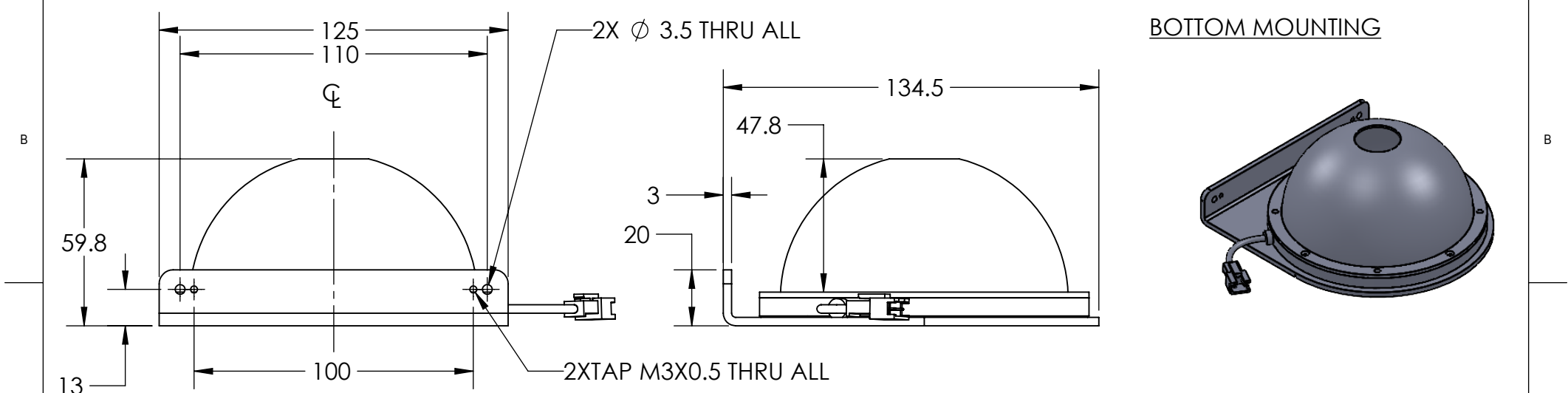

BOTTOM MOUNTING

DESIGN BY	NIZAM	UNIT:	PRODUCT SERIES: IDS5 SERIES		
CHECK BY	KB TAN	MM			
DATE	12/7/2021	REVISION:	TITLE	DRAWING LAYOUT	COLOUR:
MATERIAL	-	01	PART NO	IDS5-00-100-X-BRACKET	VOLTAGE:
FINISHING	-	SCALE:	DWG NO		CURRENT:
QTY	-	1:1			POWER:
					SHEET 1 OF 1

